



# E O N

'A line with system'

Designed by  
Peter Straka  
Vienna 2005-07

On its own, EON is clean and linear. Attach one, or more – create endless combinations.  
EON is a lighting system which allows multiple shapes and angles – squares, rectangles, zig-zags.



Process: All components of the EON lighting system are solid brass. The brass is polished and then nickel plated. Lastly the components are assembled to a system whatever required.

## E O N

Suspension  
100 set

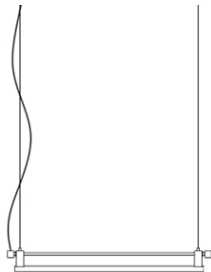

Type	Suspension light
Material	Brass
Environment	Indoors
Cable Length	2000 mm
Dimensions	1100 x 100 mm
Weight	1.4 kg
Certification	IP20 CE
EU/UK	230 V
Ceiling Rose	square 70 x 70 x 25 mm
Lamps	Linear opal LED S14s*, 15 W, 2700 K, Mains ( Phase) dimmable, 1000 lm, energy class A

070 01 101 11

Polished nickel with transparent cable

**E O N**  
Suspension  
50 set

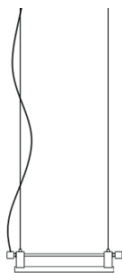

Type	Suspension light
Material	Brass
Environment	Indoors
Cable Length	2000 mm
Dimensions	600 x 100 mm
Weight	1.4 kg
Certification	IP20 CE
EU/UK	230 V
Ceiling Rose	square 70 x 70 x 25 mm
Lamps	Linear opal LED S14s*, 7 W, 2700 K, Mains ( Phase) dimmable, 450 lm, energy class A

070 02 101 11 Polished nickel with transparent cable

**E O N**  
Suspension  
100 set 2

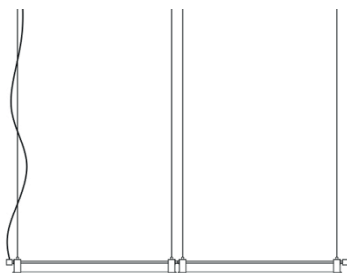

Type	Suspension light
Material	Brass
Environment	Indoors
Cable Length	2000 mm
Dimensions	2110 x 100 mm
Weight	2.4 kg
Certification	IP20 CE
EU/UK	230 V
Ceiling Rose	square 70 x 70 x 25 mm
Lamps	2 x linear opal LED S14s*, 2 x 15 W, 2700 K, Mains ( Phase) dimmable, 2 x 1000 lm, energy class A

070 03 101 11 Polished nickel with transparent cable

**E O N**  
Suspension  
100 set 3

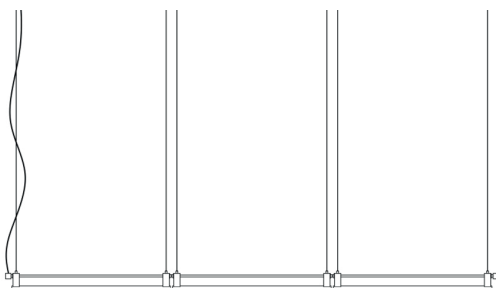

Type	Suspension light
Material	Brass
Environment	Indoors
Cable Length	2000 mm
Dimensions	3120 x 100 mm
Weight	3.3 kg
Certification	IP20 CE
EU/UK	230 V
Ceiling Rose	square 70 x 70 x 25 mm
Lamps	3 x linear opal LED S14s*, 3 x 15 W, 2700 K, Mains ( Phase) dimmable, 3 x 1000 lm, energy class A

070 04 101 11 Polished nickel with transparent cable

**E O N**

Suspension  
100 set 2  
centre cable

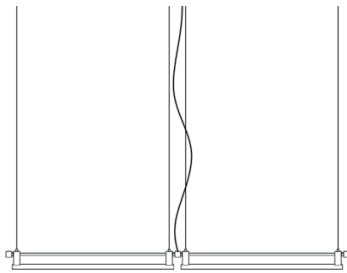

Type	Suspension light
Material	Brass
Environment	Indoors
Cable Length	2000 mm
Dimensions	2160 x 100 mm
Weight	2.4 kg
Certification	IP20 CE
EU/UK	230 V
Ceiling Rose	square 70 x 70 x 25 mm
Lamps	2 x linear opal LED S14s*, 2 x 15 W, 2700 K, Mains ( Phase) dimmable, 2 x 1000 lm, energy class A

070 05 101 11 Polished nickel with transparent cable

**E O N**

Suspension  
100 square

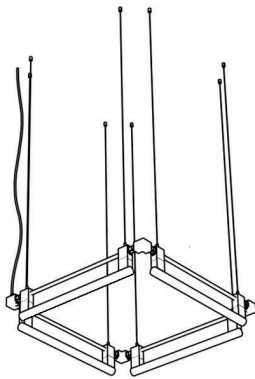

Type	Suspension light
Material	Brass
Environment	Indoors
Cable Length	2000 mm
Dimensions	1100 x 1100 x 100 mm
Weight	5 kg
Certification	IP20 CE
EU/UK	230 V
Ceiling Rose	square 70 x 70 x 25 mm
Lamps	4 x linear opal LED S14s*, 4 x 15 W, 2700 K, Mains ( Phase) dimmable, 4 x 1000 lm, energy class A

070 06 101 11 Polished nickel with transparent cable

**E O N**

Suspension  
50 square

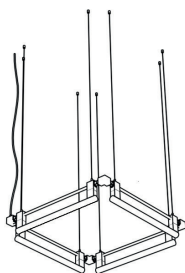

Type	Suspension light
Material	Brass
Environment	Indoors
Cable Length	2000 mm
Dimensions	600 x 600 x 100 mm
Weight	4 kg
Certification	IP20 CE
EU/UK	230 V
Ceiling Rose	square 70 x 70 x 25 mm
Lamps	4 x linear opal LED S14s*, 4 x 7 W, 2700 K, Mains ( Phase) dimmable, 4 x opal 450 lm, energy class A

070 07 101 11 Polished nickel with transparent cable

**E O N**

Suspension  
100/50 square

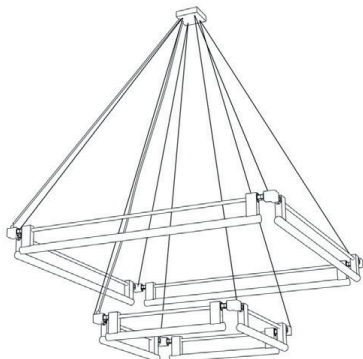

Type	Suspension light
Material	Brass
Environment	Indoors
Cable Length	2000 mm
Dimensions	1100 x 110 x 100 mm AND
Weight	600 x 600 x 100 mm
Certification	9 kg
EU/UK	IP20 CE
Ceiling Rose	230 V
Lamps	square 70 x 70 x 25 mm 4 x linear opal LED S14s*, 4 x 15 W, 2700 K, dimmable, 4 x 1000 lm, energy class A AND 4 x linear opal LED S14s*, 4 x 7W, 2700 K, Mains ( Phase) dimmable, 4 x opal 450 lm, energy class A
070 08 101 11	Polished nickel with transparent cable

\* Under unfavorable conditions these lamps can lead to acoustic noise. In case of resonance even low noise can cause audible effect. The installation as well as the dimmer or the transformer (harmonics or electronic resonance) are possible influencing factors.

\*\* Please contact sales@kaia.at for further information on dimmers etc. Please note KAIA Ltd cannot take any responsibility for the connection with your dimming or central control system. It is the customer's responsibility to ensure the compatibility with their systems.

www.kaia.at

sales@kaia.at